

Onderdelen

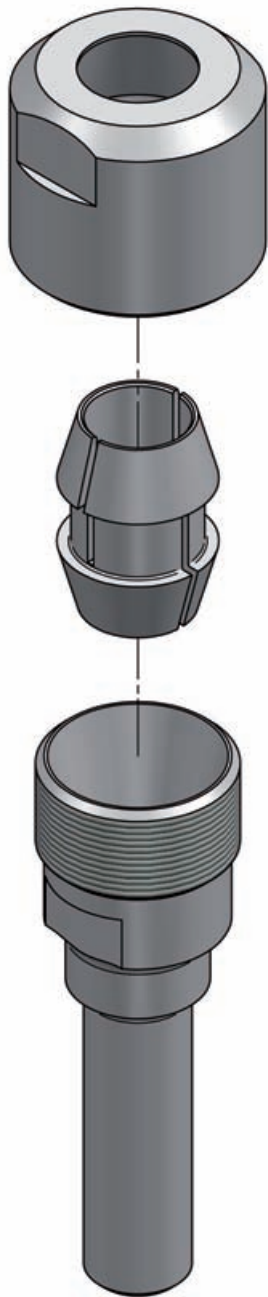

Omschrijving	Pagina
Verloop-assen	250
Spantanghouders	250
Verloopstukken	251
Spantangen	251
Vergrootbussen	251
Bouten	252
Sleutels	252
Beschermringen	252
Moeren	252
Kogellagers	253
Blokkeringsringen	253
Tussenringen en vulringen	253
Drukstukken	254

Onderdelen en accessoires

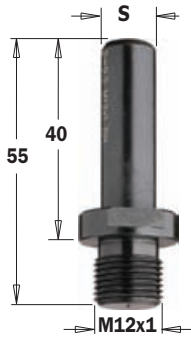

Verloop-assen

797

S mm		ARTIKELNR.
10		797.100.00
12		797.120.00
12,7		797.127.00

TECHNISCHE DETAILS:

- supersterk gereedschapstaal
- CNC-precisiedraaiwerk met geslepen kolf



Spantanghouder voor kolf

796

S mm	Voor kolfdiameter mm	ARTIKELNR.
M10	6 - 6,35 - 8 - 9,5	796.100.00
M12x1	6 - 6,35 - 8 - 9,5	796.000.00
M12x1	10 - 12 - 12,7	796.121.00

TECHNISCHE DETAILS:

- supersterk gereedschapstaal
- CNC-precisiedraaiwerk

Spantangen niet inbegrepen.



Spantanghouder voor bovenfrezen

796.001

S mm	Voor kolfdiameter mm	ARTIKELNR.
12	8	796.002.01
12	12	796.002.00
12,7	6,35	796.001.01
12,7	12,7	796.001.00

TECHNISCHE DETAILS:

- Supersterk gereedschapstaal
- CNC-precisiedraaiwerk met geslepen kolf

Inclusief spantang



Spantanghouders voor kolf

796

S mm	Voor kolfdiameter mm	ARTIKELNR.
M14x2	6 - 6,35 - 8 - 9,5	796.140.00
M14x2	10 - 12 - 12,7	796.141.00
M16x2	6 - 6,35 - 8 - 9,5	796.160.00
M16x2	10 - 12 - 12,7	796.161.00

TECHNISCHE DETAILS:

- supersterk gereedschapstaal - CNC-precisiedraaiwerk
- exclusief spantangen

Spantangen niet inbegrepen.



Spantangen

796.500/600

D ₃ mm	ARTIKELNR.
6	796.560.00
6,35	796.564.00
8	796.580.00
9,5	796.595.00
10	796.600.00
12	796.620.00
12,7	796.627.00

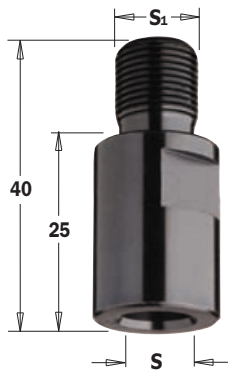

Verloopstukken

798

S mm	S ₁	ARTIKELNR.
M10	M10	798.101.00
M10	M12x1	798.102.00
M12x1	M10	798.121.00
M12x1	M12x1	798.122.00

TECHNISCHE DETAILS:
 - supersterk gereedschapstaal
 - CNC-precisiedraaiwerk met geslepen kolf

Cirkelzagen

Wisselmes
spilfrezen

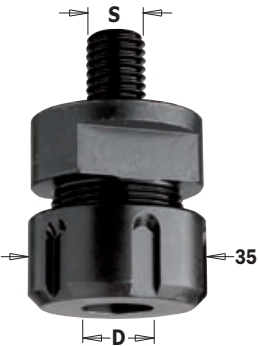

Spantanghouder ER20

796

S mm	Voor kolfdiameter mm	ARTIKELNR.
M12x1,75	3 ~ 12,7	796.122.00
M14x2	3 ~ 12,7	796.142.00
M16x2	3 ~ 12,7	796.162.00

Onderdelen: 992.483.03 Moer M25x1,5
 991.483.00 Sleutel ER20

TECHNISCHE DETAILS:
 - supersterk gereedschapstaal - CNC-precisiedraaiwerk
Spantangen niet inbegrepen

Bovenfrezen &
bovenfrezensets

CNC frezen
en houders

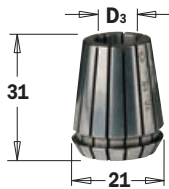

Precisie-spantang "ER20" voor houder

796.142/162

184

D ₃ mm	ARTIKELNR.	D ₃ mm	ARTIKELNR.
3	184.030.20	10	184.100.20
6	184.060.20	12	184.120.20
6,35	184.064.20	12,7	184.127.20
8	184.080.20		

Industriële boren



Spantangen voor CMT- en DeWalt-machines

796.8

D ₃ mm	ARTIKELNR.	D ₃ mm	ARTIKELNR.
6	796.860.00	10	796.900.00
6,35	796.864.00	12	796.920.00
8	796.880.00	12,7	796.927.00
9,5	796.895.00		

Overige boren
en frezen

Onderdelen



Spantangen voor Casals handfrezes

796.780

D ₃ mm	L mm	ARTIKELNR.
8	14	796.780.00

Machines
& Accessoires

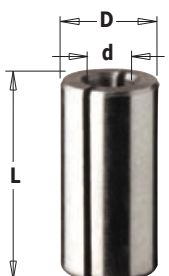

Vergrootbussen

799

d mm	D mm	L mm	ARTIKELNR.	d mm	D mm	L mm	ARTIKELNR.
6	8	25	799.060.00	8	10	25	799.280.00
6	9,5	25	799.160.00	8	12	25	799.380.00
6	12	25	799.260.00	8	12,7	25	799.480.00
6,35	8	25	799.064.00	9,5	12,7	25	799.001.00
6,35	9,5	25	799.164.00	10	12	25	799.100.00
6,35	12,7	25	799.264.00	13	16	45	799.130.00
8	9,5	25	799.180.00				

Displays

Onderdelen en accessoires

Cirkelzagen

Wisselmes
spilfrezenBovenfrezen &
bovenfrezensetsCNC frezen
en houders

Industriële boren

Overige boren
en frezen**Onderdelen**Machines
& Accessoires

Displays



1/8W



TSPEI



STEI



Torx

Bouten

990

OMSCHRIJVING	ARTIKELNR.
Bout 1/8W x 3/8"	990.058.00
Bout 1/8W x 1/2"	990.059.00
Bout TSPEI M4x6	990.004.00
Bout TSPEI M5x12 (voor schijffrees 823)	990.055.00
Bout TSPEI M5x18	990.063.00
Bout STEI M3x3 (voor blokkeerring 541)	990.005.00
Bout STEI M8x16 (voor 692)	990.064.00
Bout STEI M8x12 (voor 693)	990.065.00
Bout STEI M6x16 (voor 694)	990.066.00
Bout STEI M6x20 (voor 694)	990.084.00
Bout STEI M6x25 (voor 694)	990.085.00
Bout STEI M8x20 (voor 694)	990.086.00
Bout TCEI M4x6	990.052.00
Bout TCEI M3x6	990.051.00
Torx-bouten:	
Bout Torx M4x3,2 (voor 694.001)	990.079.00
Bout Torx T15 M5x6,5 (voor 694.100)	990.080.00
Bout Torx T25 M5x18 (voor 694.001)	990.063.00
Bout TS Torx T8 M2,5x3x5,5	990.071.00
Bout TB Torx T15 M3,5x3,5x5,5	990.072.00
Bout TB Torx T15 M3,5x5x7	990.073.00
Bout TB Torx T15 M4x3,5x5,5	990.074.00
Bout TB Torx T15 M4x6x8,5	990.075.00
Bout TB Torx T15 M4x4x6,5	990.076.00

Sleutels

991



OMSCHRIJVING	ARTIKELNR.
Binnenzeskant-sleutels:	
3/32" sleutel (voor 1/8W-bout)	991.057.00
1,5mm sleutel (voor M3-bout)	991.056.00
2mm sleutel	991.060.00
2,5mm sleutel (voor M4-bout)	991.062.00
3mm sleutel	991.067.00
4mm sleutel	991.064.00
5mm sleutel	991.065.00
6mm sleutel	991.066.00
Torx-sleutels	
Sleutel Torx T8	991.063.00
Sleutel Torx T9	991.069.00
Sleutel Torx T15	991.061.00
Sleutel Torx T20	991.072.00
Sleutel Torx T25	991.073.00
Sleutel Torx T30	991.071.00

Beschermringen

990.422/423



OMSCHRIJVING	ARTIKELNR.
Beschermring voor kogellager Ø9,5mm	990.422.00
Beschermring kogellager Ø12,7mm	990.423.00

Moeren

990.020/022







OMSCHRIJVING	ARTIKELNR.
Moer M8	990.020.00
Moer M12x1,25	990.022.00

791



Kogellagers

	D		d		Dikte	ARTIKELNR.
	mm	inches	mm	inches	mm	
	6,35	1/4	3,2	1/8	3,2	791.035.00
	9,5	3/8	4,76	3/16	3,2	791.002.00
	12,7	1/2	4,76	3/16	5	791.003.00
	12,7	1/2	6,35	1/4	4,8	791.010.00
	13		5		4	791.022.00
	13		6		5	791.023.00
	15		6		5	791.024.00
	15,8	5/8	4,76	3/16	5	791.018.00
	15,8	5/8	6,35	1/4	5	791.009.00
	16		5		5	791.006.00
	16		8		5	791.025.00
	19	3/4	4,76	3/16	7,5	791.019.00
	19		6		6	791.007.00
	19	3/4	6,35	1/4	7	791.004.00
	19		8		6	791.034.00
	19	3/4	12,7	1/2	4	791.011.00
	22		8		6	791.012.00
	22		8		7	791.005.00
	22,2	7/8	4,76	3/16	7,5	791.017.00
	22,2	7/8	9,52	3/8	7	791.021.00
	22,2	7/8	12,7	1/2	7	791.013.00
	24		8		8	791.036.00
	28		12		8	791.026.00
	28,5	1-1/8	4,76	3/16	8,4	791.014.00
	28,5	1-1/8	8		8,5	791.030.00
	28,5	1-1/8	12,7	1/2	8	791.027.00
	31,7	1-1/4	8		5	791.033.00
	31,7	1-1/4	12,7	1/2	10	791.015.00
	34,9	1-3/8	4,76	3/16	11,5	791.016.00
	34,9	1-3/8	8		11,6	791.031.00
	34,9	1-3/8	12,7	1/2	11	791.029.00
	37		12		12	791.028.00
	38,1	1-1/2	12,7	1/2	13,3	791.020.00
	19	3/4	4,76	3/16	6,8	791.041.00*
	12,7	1/2	4,76	3/16	5,8	791.042.00**
	19	3/4	4,76	3/16	7	791.043.00**

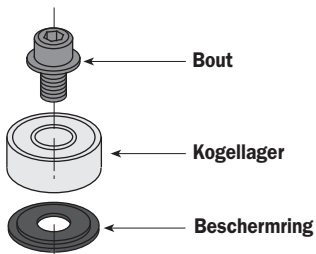

Zorg er bij montage voor dat het zwarte schild aan de bovenzijde van het lager zit. Zo weet U dat de draairichting van het lager de juiste is.



*10° Delrin® konisch lager



**Delrin® driehoekig lager



Blokkeringsringen





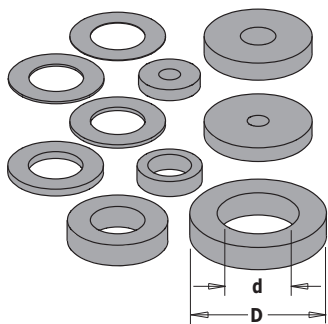









541

D mm	ARTIKELNR.	D mm	ARTIKELNR.
6	541.003.00	9,5	541.006.00
6,35	541.001.00	12	541.005.00
8	541.004.00	12,7	541.002.00



Tussenringen en vulringen

541

d mm	D mm	Dikte mm	ARTIKELNR.	d mm	D mm	Dikte mm	ARTIKELNR.	
	3,25	9	1,6	541.550.00	8	14,7	5,8	541.519.00 
	3,25	15,8	2	541.552.00	12	20	2	541.512.00 
	5,2	15,8	2,5	541.551.00	12	20	3	541.511.00 
	6,4	9,52	2,2	541.514.00	12	21	0,1	541.513.00 
	8	14	0,1	541.515.00	12	21	0,3	541.520.00 
	8	14	0,3	541.516.00	12	21	1,59	541.521.00 
	8	14	0,5	541.517.00	12	21	3,18	541.522.00 
	8	14	1	541.518.00	12	21	6,16	541.523.00 
	8	14,7	3	541.500.00	12	21	1	541.524.00 
	8	14,7	4	541.501.00	12	21	0,5	541.525.00 

Draadring voor freeskop 694.001
695.996

OMSCHRIJVING	ARTIKELNR.
Draadring M4 (Ø10x1,6mm)	695.996.01
Draadring M4 (Ø12x1,7mm)	695.996.02

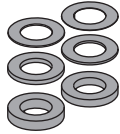
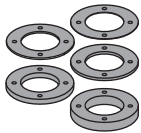
Sets geslepen freesdoornringen
695.998

Ringensets

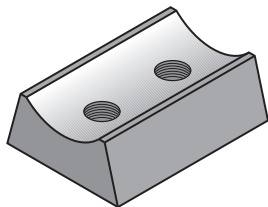
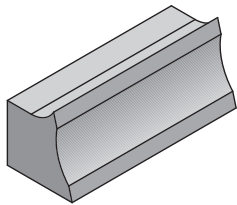
Ringensets met pengaten

OMSCHRIJVING	VOOR FREESKOP	ARTIKELNR.
Set ringen Ø50x9x30mm	694.015	695.998.01
Set ringen Ø50x9x31,75mm	694.015	695.998.02
Set ringen Ø55x9x35mm	694.015	695.998.03
Set ringen Ø60x9x40mm	694.015	695.998.04
Set ringen Ø70x9x50mm	694.015	695.998.05
Set ringen Ø50x33x30mm	694.005	695.998.11
Set ringen Ø50x33x31,75mm	694.005	695.998.12
Set ringen Ø55x33x35mm	694.005	695.998.13
Set ringen Ø60x33x40mm	694.005	695.998.14
Set ringen Ø70x22x50mm	694.005	695.998.15
Set ringen Ø65x8x30mm	694.001 en 694.015	695.998.21
Set ringen Ø65x8x31,75mm met pengaten	694.001 en 694.015	695.998.22
Set ringen Ø60x8x35mm met pengaten	694.001 en 694.015	695.998.23
Set ringen Ø80x8x40mm met pengaten	694.001 en 694.015	695.998.24
Set ringen Ø80x8x50mm met pengaten	694.001 en 694.015	695.998.25

Drukstukken
692-693-695

OMSCHRIJVING	ARTIKELNR.
Drukstukken voor freeskoppen	
Drukstuk 38x15x16mm voor lichtmetalen freeskoppen	692.999.01
Drukstuk 38x22,5x13mm voor stalen freeskoppen	692.999.02
Drukstuk 38x26x13mm voor lichtmetalen freeskoppen	693.999.01
Drukstuk 38x28x12,5mm voor stalen freeskoppen	693.999.02
Drukstuk 38x15x16mm voor lichtmetalen freeskoppen	695.018.01
Drukstuk 16x11x9,5mm	695.999.16
Drukstuk 17x11x9,5mm	695.999.17
Drukstuk 22x11x9,5mm	695.999.22
Drukstuk 31x11x9,5mm	695.999.31
Drukstuk 38x11x9,5mm	695.999.38
Drukstuk 39x11x9,5mm	695.999.39
Drukstuk 41x11x9,5mm	695.999.41
Drukstuk 42x11x9,5mm	695.999.42
Drukstuk 46x11x9,5mm	695.999.46
Drukstuk 49x11x9,5mm	695.999.49
Drukstuk 53x11x9,5mm	695.999.53
Drukstuk 7x11x9,5mm	695.999.07
Drukstuk 23x11x9,5mm	695.999.23
Drukstuk 23x11x9,5mm	695.999.24
Drukstukken voor wisselmesbovenfrezen:	
Drukstuk D=8x20mm	651.999.01
Drukstuk D=10-12-12,7x30mm	651.999.02
Drukstuk D=12-12,7x50mm	651.999.03